

# KIT SIMONCLOTHING FORTE DOUBLE 2

## 200 x 150 x 75 cm

### 78.7" x 59.1" x 29.5"

**5 years**  
SIMONRACK  
GUARANTEE

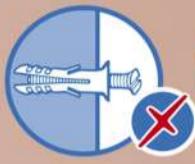

### OPTIONAL

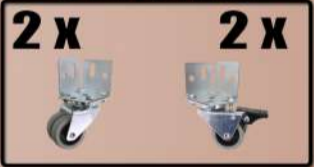

\*MEDIDAS EN USO / USED MEASUREMENTS / MASSSTÄBEN IM GEBRAUCH / MESURES EN EMPLOI / MEDIDAS EN USO  
1975 x 1510 x 760 mm (77.7" x 59.4" x 29.9")



ESTANTERIAS SIMON S.L. B. 50.556.463  
PG. ALFAMEN C/ POLIGONO C. N°3  
ALFAMEN (ZARAGOZA)



**Simon Rack**  
SINCE 1964 - MANUFACTURER



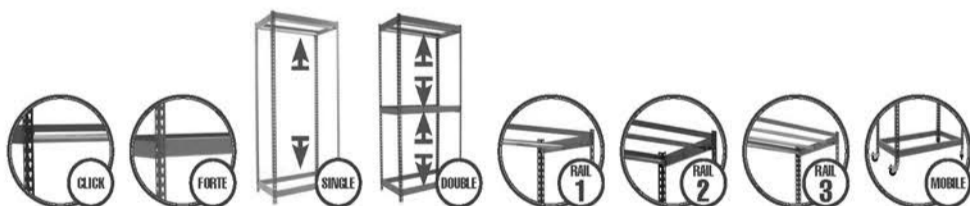
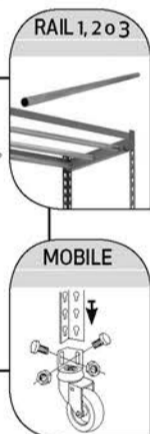
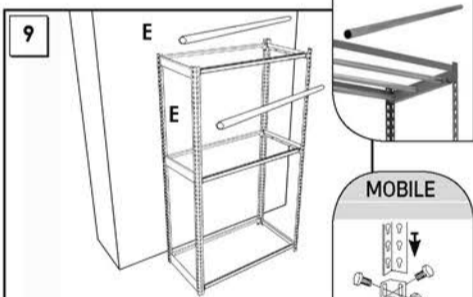
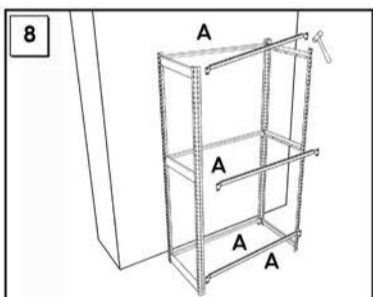
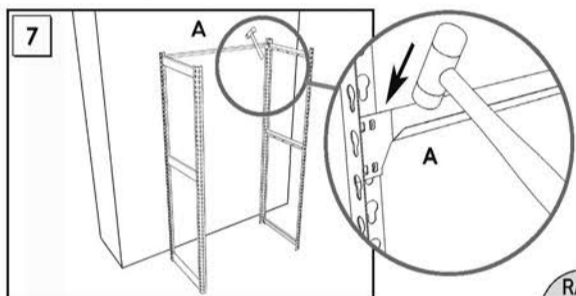
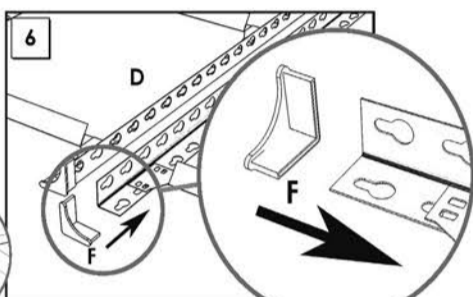
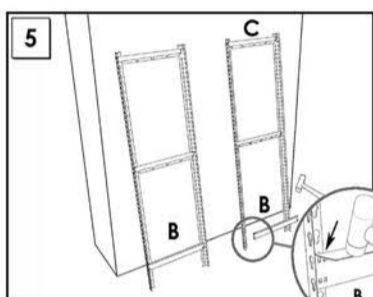
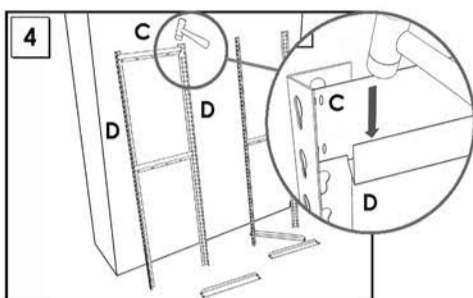
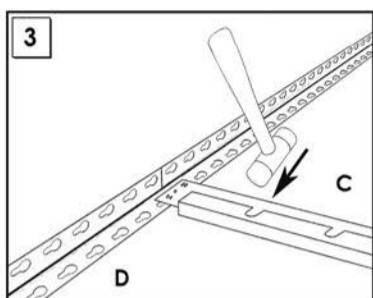
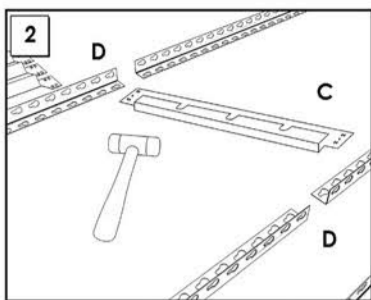
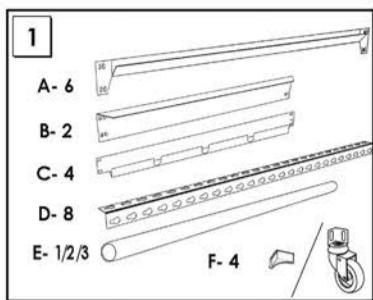

www.simonrack.com • www.simonrack.com • www.simonrack.com • www.simonrack.com

<p><b>SIMONCLASSIC</b></p> <p>150 kg 350 lb</p>	<p><b>SIMONCLICK</b></p> <p>400 kg 900 lb</p>	<p><b>SIMONTALLER</b></p> <p>700 kg 1550 lb</p>	<p><b>SIMONAUTO</b></p> <p>300 kg 660 lb</p>
<p><b>SIMONWORK</b></p> <p>800 kg 1800 lb</p>	<p><b>SIMONLOCKER</b></p>	<p><b>SIMONOFFICE</b></p> <p>275 kg 600 lb</p>	<p><b>SIMONHOME</b></p> <p>150 kg 350 lb</p>
<p><b>SIMONGARDEN</b></p> <p>600 kg 1350 lb</p>	<p><b>SIMONTITÁN</b></p> <p>900 kg 1990 lb</p>	<p><b>SIMONINOX</b></p>	<p><b>SIMONINDUSTRIAL</b></p> <p>SIMONPALET 4500 kg 9950 lb</p> <p>SIMONLEVER</p> <p>ALTILOS Y PASILLOS ELEVADORES • PLATAFORMAS Y MEZZANINES • LAGEFÜR HÖHEN • PLATES FORMES ET MEZZANINES</p>