

# KIT SIMONCLOTHING SINGLE 2

## 200 x 120 x 50 cm

(78.7" x 47.2" x 29.5")

**5** Años Garantía  
 Years Guarantee  
 Jahre Garantie  
 Ans Garantie  
 Anos de Garantia

**SIMONRACK**

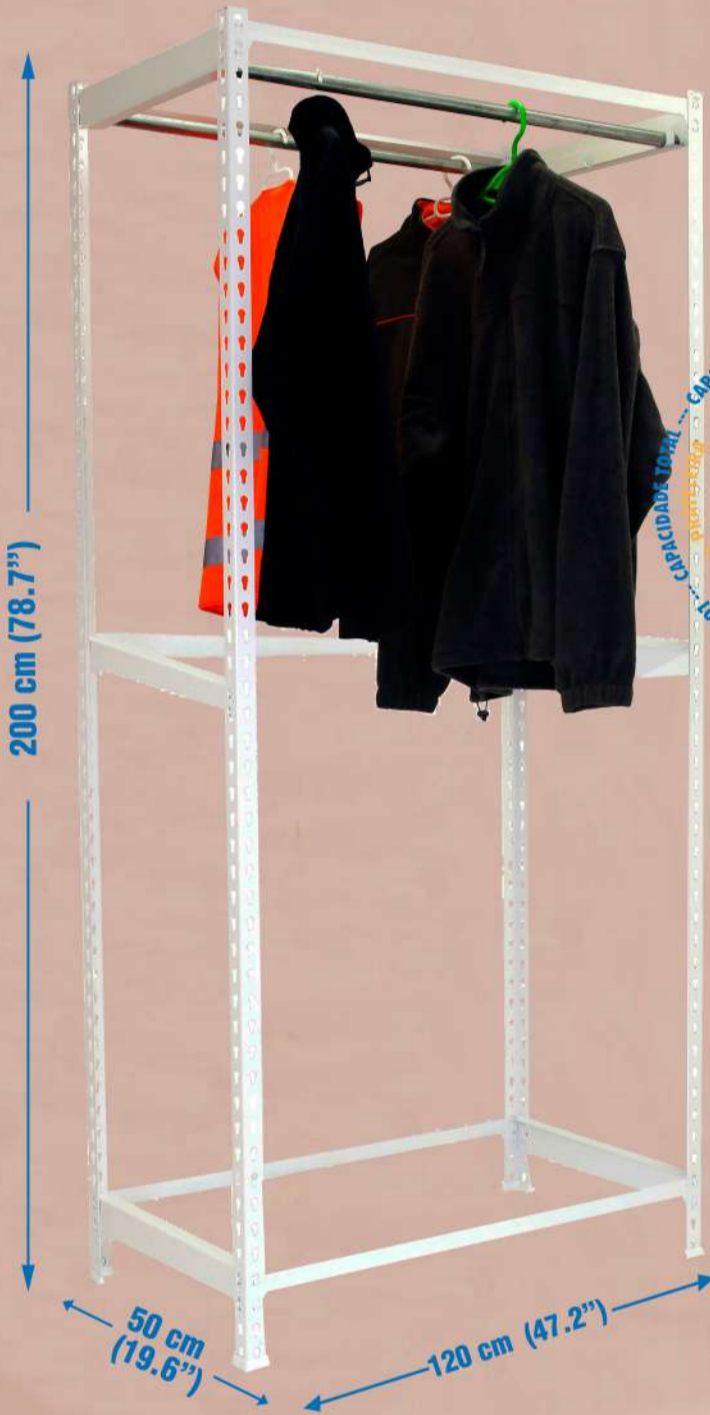

### OPTIONAL



- 4 x  50 cm (19.6")
- 6 x  120 cm (31.5")
- 2 x  50 cm (19.6")
- 4 x  200 cm (78.7")
- 2 x  120 cm (47.2")
- 4 x 









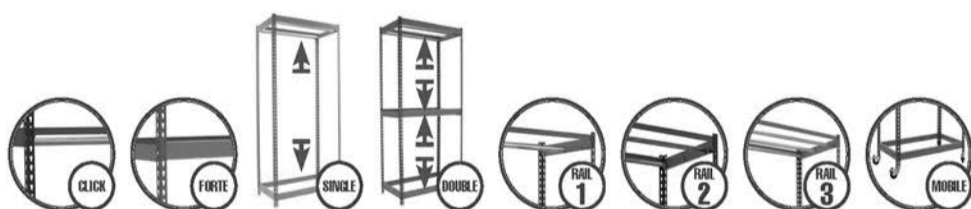
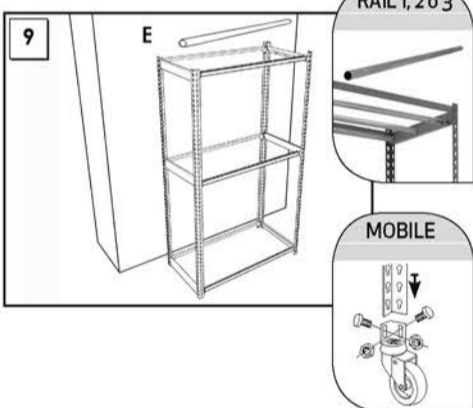
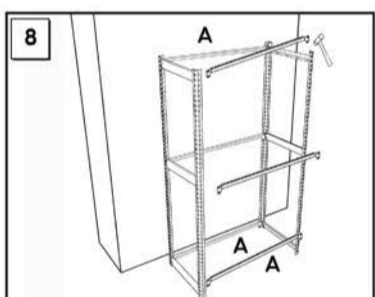
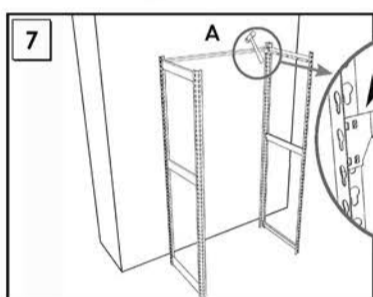
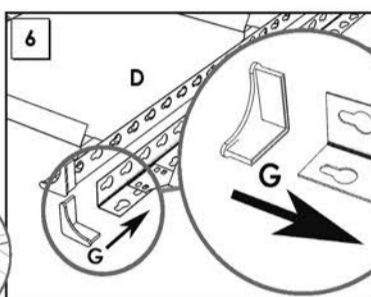
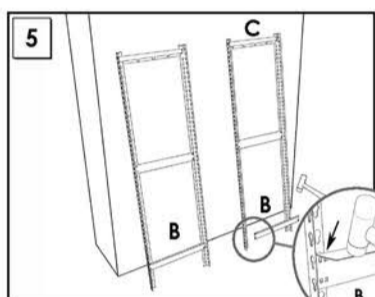
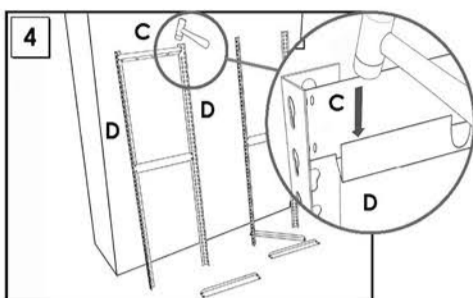
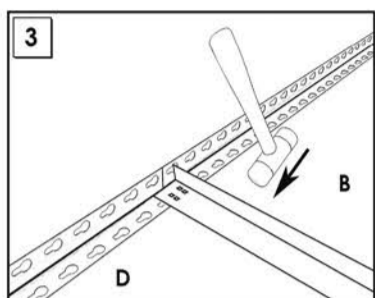
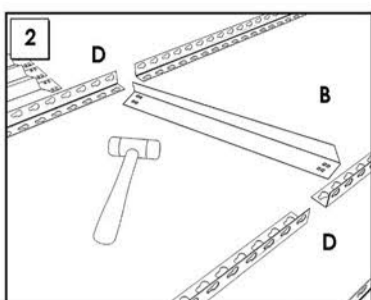
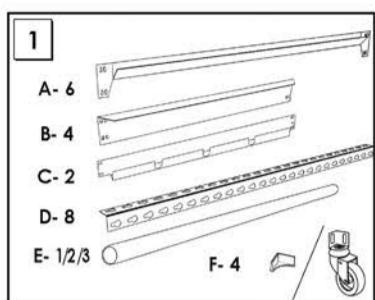

**Simon Rack**  
 SINCE 1964 - MANUFACTURER



INSTRUCCIONES  
 INSTRUCTIONS  
 ANLEITUNG  
 INSTRUCTIONS



www.simonrack.com • www.simonrack.com • www.simonrack.com • www.simonrack.com

SIMONCLASSIC	SIMONCLICK	SIMONTALLER	SIMONAUTO
 <ul style="list-style-type: none"> <li>150 kg</li> <li>350 lb</li> </ul>	 <ul style="list-style-type: none"> <li>400 kg</li> <li>900 lb</li> </ul>	 <ul style="list-style-type: none"> <li>700 kg</li> <li>1550 lb</li> </ul>	 <ul style="list-style-type: none"> <li>300 kg</li> <li>660 lb</li> </ul>
SIMONWORK	SIMONLOCKER	SIMONOFFICE	SIMONHOME
 <ul style="list-style-type: none"> <li>800 kg</li> <li>1800 lb</li> </ul>		 <ul style="list-style-type: none"> <li>275 kg</li> <li>600 lb</li> </ul>	 <ul style="list-style-type: none"> <li>150 kg</li> <li>350 lb</li> </ul>
SIMONGARDEN	SIMONTITÁN	SIMONINOX	SIMONINDUSTRIAL
 <ul style="list-style-type: none"> <li>600 kg</li> <li>1350 lb</li> </ul>	 <ul style="list-style-type: none"> <li>900 kg</li> <li>1990 lb</li> </ul>		 <ul style="list-style-type: none"> <li>4500 kg</li> <li>9950 lb</li> </ul> <p>ALTILOS Y PASILLOS ELEVADORES • PLATAFORMAS Y MEZZANINES • LAGEBÜRGERNEN • PLATES FORMES ET MEZZANINES</p>