

180 x 90 x 40 cm* 70.9" x 35.4" x 15.8"

COMFORT 5/400

5 Años Garantía
Years Guarantee
Jahre Garantie
Ans Garantie
Anos de Garantia
SIMONRACK



**500 kg
(1102 lb)
Total**

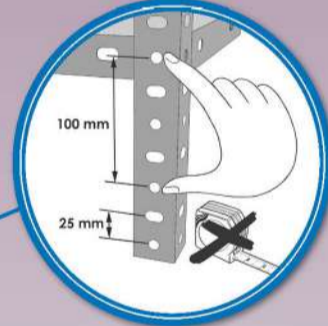
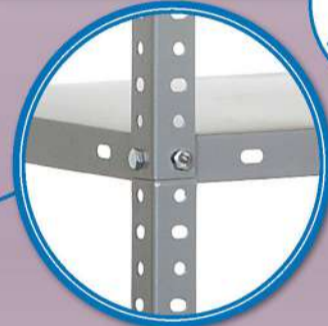

*MEDIDAS EN USO: 1803 x 914 x 414 mm
USED MEASUREMENTS: 70.98" x 35.98" x 16.30"



ESTANTERIAS SIMON S.L. B.50.556.463
PG. ALFAMEN C/ POLIGONO C, N°3
ALFAMEN (ZARAGOZA)



www.simonrack.com



INSTRUCTIONS

